

- Shapley, and J. A. Osborn, *ibid.*, **96**, 4038 (1974); (d) T. Kaneshima, K. Kawakami, and T. Tanaka, *Inorg. Chem.*, **13**, 2198 (1974); *Inorg. Chim. Acta*, **15**, 161 (1975); T. Kaneshima, Y. Yumoto, K. Kawakami, and T. Tanaka, *ibid.*, **18**, 29 (1976); (e) K. van Putle and A. vander Ent, *ibid.*, **7**, 497 (1973); A. Onderdelinden and A. vander Ent, *ibid.*, **6**, 420 (1972); (f) H. C. Clark and L. E. Manzer, *Inorg. Chem.*, **13**, 1996 (1974); (g) P. W. Clark and A. J. Jones, *J. Organomet. Chem.*, **122**, C41 (1976); (h) C. A. Tolman, S. D. Ittel, A. D. English, and J. P. Jesson, *J. Am. Chem. Soc.*, **100**, 4080 (1978).
- (22) J. W. Fallor, private communication; *Adv. Organomet. Chem.*, **16**, 211 (1977).
- (23) (a) R. A. Love, T. F. Koetzle, G. J. B. Williams, L. C. Andrews, and R. Bau, *Inorg. Chem.*, **14**, 2653 (1975); (b) W. C. Hamilton, K. A. Klenderman, and R. Spratley, *Acta Crystallogr., Sect. A*, **25**, S172 (1969); (c) J. A. J. Jarvis, B. T. Kilbourn, and P. G. Owston, *Acta Crystallogr., Sect. B*, **27**, 366 (1971); (d) E. Benedetti, P. Corradini, and C. Pedone, *J. Organomet. Chem.*, **18**, 203 (1969); (e) J. A. Evans and D. R. Russell, *Chem. Commun.*, 197 (1971); (f) R. G. Ball and N. C. Payne, *Inorg. Chem.*, **15**, 2494 (1976); (g) P. Mura, R. Spagna, G. Ughetto, and L. Zambonelli, *Acta Crystallogr., Sect. B*, **32**, 2532 (1976); R. Spagna and L. Zambonelli, *J. Chem. Soc. A*, 2544 (1971); R. Spagna, L. M. Venanzi, and L. Zambonelli, *Inorg. Chim. Acta*, **4**, 475 (1970); R. Spagna, G. Ughetto, and L. Zambonelli, *Acta Crystallogr., Sect. B*, **32**, 2532 (1976); (h) M. A. Bennett, P. W. Clark, G. B. Robertson, and P. O. Whimp, *J. Chem. Soc., Chem. Commun.*, 1011 (1972); (i) J.-J. Bonnet, Y. Jeannin, A. Maisonnat, P. Kalck, and R. Poilblanc, *C. R. Acad. Sci., Ser. C*, **281**, 15 (1975); (j) M. Green, J. A. K. Howard, R. P. Hughes, S. C. Kelleff, and P. Woodward, *J. Chem. Soc., Dalton Trans.*, 2007 (1975); (k) C. Pedone and E. Benedetti, *J. Organomet. Chem.*, **29**, 443 (1971); (l) S. Merlino, R. Lazzaroni, and G. Montagnoli, *ibid.*, **30**, C93 (1971); (m) A. De Renzi, B. Di Blasio, G. Paiaro, A. Panunzi, and C. Pedone, *Gazz. Chim. Ital.*, **106**, 765 (1976); (n) S. C. Nyburg, K. Simpson, and W. Wong-Ng, *J. Chem. Soc., Dalton Trans.*, 1865 (1976); see also D. G. Cooper, G. K. Hamer, J. Powell, and W. F. Reynolds, *J. Chem. Soc., Chem. Commun.*, 449 (1973); (o) F. Sartori and L. Leoni, *Acta Crystallogr., Sect. B*, **32**, 145 (1976); (p) R. Mason and G. B. Robertson, *J. Chem. Soc. A*, 492 (1969); (q) C. Busetto, A. D'Alfonso, F. Maspero, G. Perego, and A. Zazzetta, *J. Chem. Soc., Dalton Trans.*, 1828 (1977); (r) F. A. Cotton, J. N. Francis, B. A. Frenz, and M. Tsutsui, *J. Am. Chem. Soc.*, **95**, 2483 (1973); (s) P. G. Eller, R. R. Ryan, and R. O. Schaeffer, *Cryst. Struct. Commun.*, **6**, 163 (1977); (t) R. C. Elder and F. Pesa, *Acta Crystallogr., Sect. B*, **34**, 268 (1978); (u) R. Spagna and L. Zambonelli, *ibid.*, **28**, 2760 (1972). (v) An 18° deviation from the upright geometry is found in the relatively unconstrained ethylene complex studied by F. Caruso, R. Spagna, and L. Zambonelli, *Inorg. Chim. Acta*, **32**, L23 (1979).
- (24) (a) R. J. Dubey, *Acta Crystallogr., Sect. B*, **32**, 199 (1976); (b) G. R. Davies, W. Hewertson, R. H. B. Mais, P. G. Owston, and C. G. Patel, *J. Chem. Soc. A*, 1873 (1970); (c) B. W. Davies and N. C. Payne, *Can. J. Chem.*, **51**, 3477 (1973).
- (25) (a) C. E. Holloway, G. Hulley, B. F. G. Johnson, and J. Lewis, *J. Chem. Soc. A*, 53 (1969); 1653 (1970); J. Ashley-Smith, Z. Douek, B. F. G. Johnson, and J. Lewis, *J. Chem. Soc., Dalton Trans.*, 128 (1974); J. Ashley-Smith, I. Douek, B. F. G. Johnson, and J. Lewis, *ibid.*, 1776 (1972); (b) M. Herberhold, C. G. Kreiter, and G. O. Widersatz, *J. Organomet. Chem.*, **120**, 103 (1976); M. Herberhold and G. O. Widersatz, *Chem. Ber.*, **109**, 3557 (1976); (c) H. Boucher and B. Bosnich, *Inorg. Chem.*, **16**, 717 (1977); (d) M. A. Bennett, R. N. Johnson, and I. B. Tomkins, *J. Organomet. Chem.*, **133**, 231 (1977); (e) R. E. Ghosh, T. C. Waddington, and C. J. Wright, *J. Chem. Soc., Faraday Trans. 2*, 275 (1973). The barrier reported for Zeise's salt by inelastic neutron scattering is much too large, based on the work cited above.
- (26) The ethylene hydrogens were bent back 16° in this calculation.
- (27) Here, as elsewhere in the paper, we are greatly aided by the fragment MO methodology: (a) R. Hoffmann, H. Fujimoto, J. R. Swenson, and C.-C. Wan, *J. Am. Chem. Soc.*, **95**, 7644 (1973); (b) H. Fujimoto and R. Hoffmann, *J. Phys. Chem.*, **78**, 1167 (1974).
- (28) D. L. Thorn and R. Hoffmann, *J. Am. Chem. Soc.*, **100**, 2079 (1978).
- (29) (a) D. J. Cardin, B. Cetinkaya, M. F. Lappert, L. J. Manojlovic-Muir, and K. W. Muir, *Chem. Commun.*, 400 (1971); D. J. Cardin, B. Cetinkaya, E. Cetinkaya, M. F. Lappert, L. J. Manojlovic-Muir, and K. W. Muir, *J. Organomet. Chem.*, **44**, C59 (1972); W. M. Butler and J. H. Enemark, *Inorg. Chem.*, **12**, 540 (1973); O. P. Anderson and A. B. Packard, *ibid.*, **17**, 1333 (1978). (b) The barriers of rotation for these complexes may be found in M. J. Doyle and M. F. Lappert, *Chem. Commun.*, 679 (1971).
- (30) W. M. Butler, J. H. Enemark, J. Parks, and A. L. Balch, *Inorg. Chem.*, **12**, 451 (1973).
- (31) C. B. Anderson and J. T. Michalowski, *J. Chem. Soc., Chem. Commun.*, 459 (1972). One wishes that the structure of dipentene-PtCl₂, N. C. Baenziger, R. C. Medrud, and J. R. Doyle, *Acta Crystallogr.*, **18**, 237 (1965), were known more precisely. It has one double bond perpendicular and one twisted 62° from the coordination plane, and the distances from Pt to the carbons of the more twisted ethylene appear shorter.
- (32) M.M.-L. Chen, Ph.D. Thesis, Cornell University, 1976. See also C. Bachmann, J. Demuyneck, and A. Veillard, *J. Am. Chem. Soc.*, **100**, 2366 (1978).
- (33) (a) C. G. Kreiter and H. Strack, *Z. Naturforsch. B*, **30**, 748 (1975); U. Koemr, C. G. Kreiter, and H. Strack, *J. Organomet. Chem.*, **148**, 179 (1978); (b) L. D. Brown, C. F. J. Barnard, J. A. Daniels, R. J. Mawby, and J. A. Ibers, *Inorg. Chem.*, **17**, 2932 (1978); (c) P. E. Riley and R. E. Davis, *ibid.*, **14**, 2507 (1975). The argument on lack of metal-olefin π^* bonding in this paper is not correct. See also M. Bottrill, R. Goddard, M. Green, R. P. Hughes, M. K. Lloyd, B. Lewis, and P. Woodward, *J. Chem. Soc., Chem. Commun.*, 253 (1975).
- (34) For other structures exhibiting this asymmetry see ref 23j and M. K. Cooper, T. J. Guernsey, M. Elder, and M. McPartlin, *J. Organomet. Chem.*, C22 (1977).
- (35) L. Libit and R. Hoffmann, *J. Am. Chem. Soc.*, **96**, 1370 (1974).
- (36) W. L. Jorgensen and L. Salem, "The Organic Chemist's Book of Orbitals", Academic Press, New York, 1973, pp 19-23, 115.
- (37) See, for instance, J. Hillis, J. Francis, M. Ori, and M. Tsutsui, *J. Am. Chem. Soc.*, **96**, 4800 (1974).
- (38) A comprehensive, up-to-date discussion of the problem is given by Dewar and Ford in ref 1a. For reasoning by others with similar conclusions see: (a) J. Chatt, *Chim. Inorg. Accad. Nazl. Lincei, Roma*, **113** (1961); (b) ref 16; (c) W. H. Baddley, *J. Am. Chem. Soc.*, **90**, 3705 (1968), and ref 7i; (d) ref 7e and 17d.
- (39) R. Hoffmann, *J. Chem. Phys.*, **39**, 1397 (1963); R. Hoffmann and W. N. Lipscomb, *ibid.*, **36**, 3179, 3489 (1962); **37**, 2872 (1962).
- (40) J. W. Richardson, W. C. Nieuwpoort, R. R. Powell, and W. F. Edgell, *J. Chem. Phys.*, **36**, 1057 (1962); H. Basch and H. B. Gray, *Theor. Chim. Acta*, **4**, 367 (1966).
- (41) R. H. Summerville and R. Hoffmann, *J. Am. Chem. Soc.*, **98**, 7240 (1976).
- (42) J. H. Ammeter, H.-B. Bürgi, J. C. Thibeault, and R. Hoffmann, *J. Am. Chem. Soc.*, **100**, 3686 (1978).

Polyene-ML₂ and -ML₄ Complexes. Conformational Preferences and Barriers of Rotation

Thomas A. Albright, Roald Hoffmann,* Yuk-ching Tse, and Ted D'Ottavio

Contribution from the Departments of Chemistry, Cornell University, Ithaca, New York 14853, and University of Houston, Houston, Texas 77004. Received September 19, 1978

Abstract: Rotational barriers in acyclic and cyclic polyene-ML₂ and -ML₄ complexes are analyzed by subdividing the molecules into polyene and ML_n fragments. In C_nH_n-ML₂ the inherently small rotational barrier may be strongly perturbed by substitution patterns which create an electron density asymmetry. Slipping and geometrical deformations of the coordinated polyene may also occur. In acyclic polyene-ML₂ complexes generally large barriers are to be expected, with well-defined equilibrium conformations. The analysis of ML₄ complexes follows similar lines, but is complicated by a geometrical degree of freedom which relates C_{4v} and C_{2v} ML₄ fragment geometries.

In several preceding papers we have analyzed the bonding, conformational preferences, and rotational barriers in poly-

ene-ML₃¹ and ethylene-ML₂₋₅ transition metal complexes.² The barrier to internal rotation about the metal-ligand coordination axis is a most direct probe of the bonding in these compounds. In this paper we study the important class of

* Cornell University.

polyene and cyclopolyene complexes with C_{2v} ML₂ and C_{2v} and C_{4v} ML₄ metal fragments.

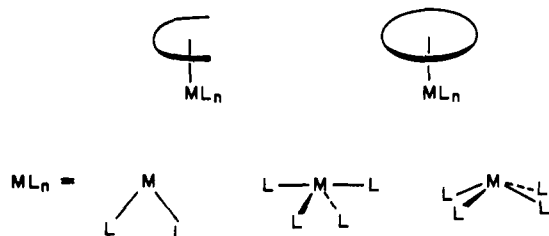

ML₂ and ML₄ Fragments

One convenient way to approach the barrier problem is to dissect the molecule conceptually into a polyene and an ML_n fragment, and then reconstruct it in those geometries which correspond to the end points of some rotational process. In the reassembly, accomplished with the language of perturbation theory, one looks for differentials in interaction between the extreme conformations. Where symmetry arguments are insufficient the analysis is aided by extended Hückel calculations, described in the Appendix. Our study relies heavily on the accompanying discussion of olefin rotational barriers.²

The frontier orbitals of ML_n fragments have been discussed in detail elsewhere.¹⁻³ The valence orbitals of three of them, a C_{2v} Ni(CO)₂ and C_{2v} and C_{4v} Fe(CO)₄, are shown in Figure 1.

The a₁ orbitals of each fragment figure in σ bonding, but being cylindrically symmetrical will not create a rotational barrier. The a₂ orbitals may play a special role in those cases where π bonding is not decisive. But it is really the π-type orbitals of these fragments, 1b₁ and b₂, which will determine the major conformational preferences. In the two C_{2v} fragments the 1b₁ and b₂ orbitals are strongly split in energy. They also differ in hybridization, the b₂ xz orbital having a significantly greater extent in space away from its two (equatorial) carbonyls and toward the incoming polyene ligand. A higher lying orbital which we have labeled 2b₁ in the Ni(CO)₂ fragment is important when the M(CO)₂ unit is pyramidalized in polyene-M(CO)₂ compounds.^{3d} However, 2b₁ does not play a significant role in determining rotational barriers because of its relatively high energy and poor overlap compared to 1b₁ and b₂.² We have neglected its presence in the following discussions. In the C_{4v} fragment there is no distinction between 1b₁ and b₂, both forming a degenerate e orbital. These points have been discussed in detail elsewhere³—in those fragments where a difference between b₁ and b₂ exists it is crucial in fixing the orientation of a complexed ethylene. So it will be for a polyene as well.

To obtain a large rotational barrier in a polyene-ML_n complex requires an exploitation of the b₁-b₂ differential. Both by the energy and overlap criteria of perturbation theory the b₂ interacts better. There will be a significant barrier when the polyene possesses a relatively low-lying unfilled orbital, non-degenerate and of π pseudosymmetry so that it can interact with the b₂. If the orbital is indeed pure π, as it is in the case of ethylene, then the preferred orientation is fixed, as in 1. But

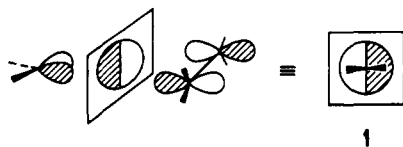

if the LUMO of the polyene has more angular nodes, then in principle more orientations are possible, 2a-c. A distinction among these can be obtained if the polyene LUMO electronic density is different in regions A, B, and C in 2. In a general way

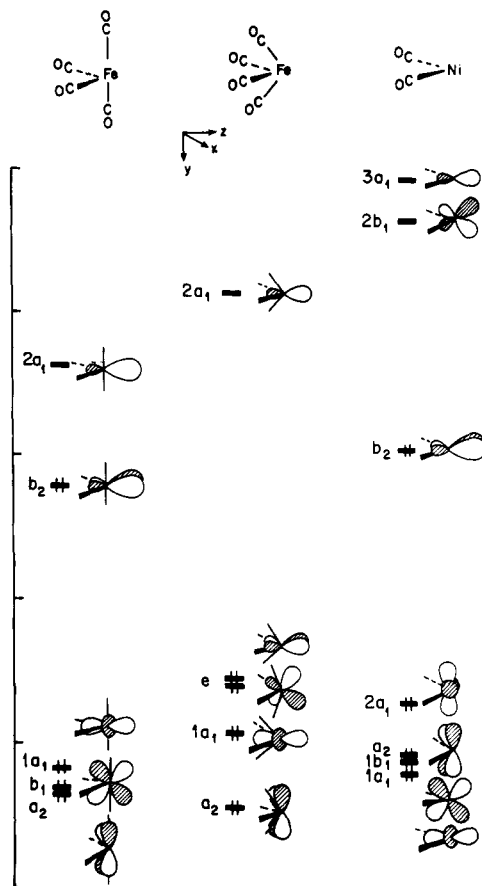
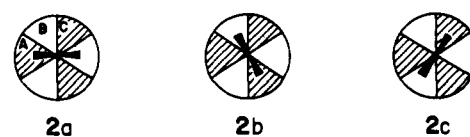
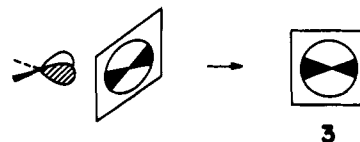

Figure 1. Frontier orbitals of some metal fragments. The energy scale markings are in eV.



the b₂ ML_n fragment orbital acts as a template—it requires a π orbital, and it requires electron density *in* the plane of ML₂. The density requirement is shown schematically in 3. Here the



cross hatching does *not* stand for the orbital phase, but for the region of greater *electron density*. That this greater electron density is in an orbital that matches in phase the b₂ is understood.

The prescription for a large barrier may seem complicated, but will prove to be simple in practice when we examine some specific cases. Let us begin with some cyclic polyenes.

Cyclic Polyene-ML₂ Complexes

The class of molecules under consideration consists of cyclic C_nH_n-ML₂, where the polyene rings are regular polygons and the projection of the metal onto the polyene lies in the center. From our general knowledge of molecular potentials one would anyway not expect a large barrier when a twofold rotor is pitted against a three-, four-, five-, six- . . . fold one. The electronic argument would also say that these compounds can have no substantial rotational barriers. This is a consequence of the partitioning of the valence orbitals of C_nH_n into e sets; when

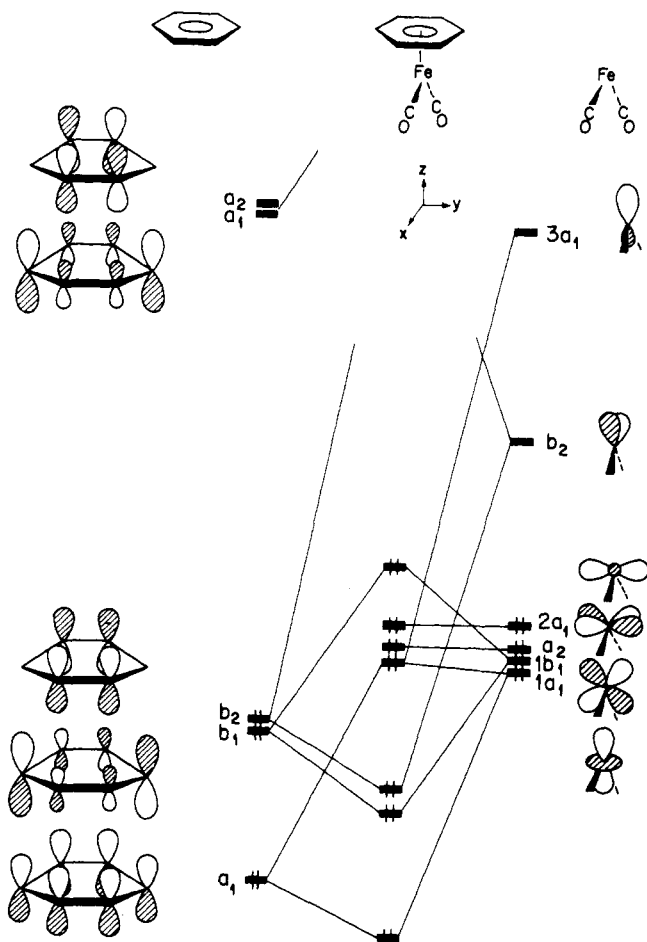
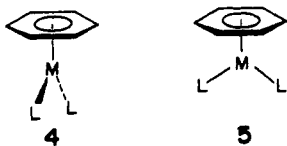

Figure 2. Interaction diagram for benzene- $\text{Fe}(\text{CO})_2$. The $2b_1$ orbital of $\text{Fe}(\text{CO})_2$ has been omitted.

each e set is taken together this forms a cylindrically symmetrical charge distribution. Extended Hückel calculations on $\text{C}_n\text{H}_n\text{-M}(\text{CO})_2$, $n = 3-6$, confirm this hypothesis. The computed barriers range from 0.2 to 0.01 kcal/mol. However, perturbation of these e sets by substituents, introduction of heteroatoms into the polyenes, or in some cases, geometrical deformations may generate substantial barriers. We shall show examples of this behavior in this section.

Let us first consider benzene- $\text{Fe}(\text{CO})_2$. An interaction diagram given for this complex in Figure 2 shows a strong interaction between b_2 and the benzene π orbital of b_2 symmetry. The metal orbitals of δ symmetry, a_2 and $2a_1$, are not stabilized much by the benzene π^* orbitals of a_2 and a_1 symmetry, because of the mixing of lower lying ring σ orbitals. Finally there is a strong interaction between $1b_1$ and the benzene b_1 π orbital. This interaction is a repulsive one and the HOMO of the molecule is the antibonding combinations of these two fragments. The interaction diagram corresponds to the conformation given by **4**. Upon rotation to **5** the diagram is left un-



changed except for the interchange of symmetry labels for the b_1 and b_2 benzene π orbitals. Since these are actually two components of a degenerate e_{1g} there is essentially no change in energy in going from **4** to **5** (calculated 0.07 kcal/mol), holding the benzene ring planar.

However, an isoelectronic compound, **6**, adopts a slightly boat-shaped conformation.⁴ The dihedral angles between the

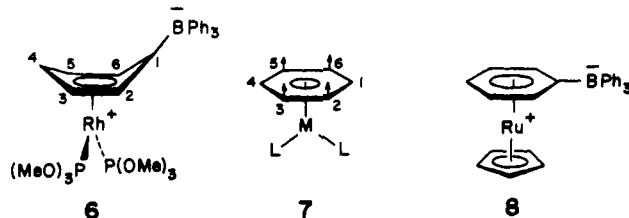

$\text{C}_2\text{-C}_1\text{-C}_6$ and $\text{C}_3\text{-C}_4\text{-C}_5$ planes and $\text{C}_2\text{-C}_3\text{-C}_5\text{-C}_6$ were 7.0 and 4.9°, respectively. We feel that this deformation may be traced to the HOMO in the molecule, the antibonding combination of $1b_1$ with the benzene π orbital of b_1 symmetry. Moving carbons 1 and 4 out of the plane of the benzene ring reduces the antibonding. If the molecule adopts the other ML_2 conformation, then one would expect the distortion shown in **7**. The interaction of $1b_1$ is now with the other member of the benzene π set. This does indeed happen for benzeneruthenium cyclooctadiene⁵ (the two opposite π bonds of the cyclooctadiene act as the L_2 unit). The angle between the planes formed from $\text{C}_1\text{-C}_2\text{-C}_3\text{-C}_4$ and $\text{C}_4\text{-C}_5\text{-C}_6\text{-C}_1$ is 5.2°.⁵ Further supporting evidence comes from the fact that the benzene ring in **8** is completely planar.⁶ The directionality of ML_2 orbitals is lost in the MCp fragment. Furthermore, (π -toluene)cobalt bis(hexafluorophenyl), which contains one less electron than **6**, also shows a planar benzene ring,⁷ which is consistent with the idea that the HOMO is responsible for the driving force behind the distortions. An important point is that these distortions, while understandable, are small and occur in both conformations. Therefore, it is still predicted that there will only be a tiny rotation barrier in benzene- ML_2 complexes.

The small barrier in benzene- $\text{Fe}(\text{CO})_2$ can be turned into a gigantic one by splitting the degeneracy of the b_1 and b_2 π orbitals (see Figure 2). For example, consider the replacement of the two para carbons by less electronegative boron atoms. Such a compound has been prepared and shown to have the conformation given by **9** rather than **10**.⁸ We calculate that **9**

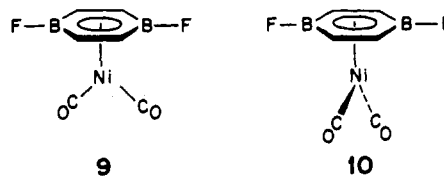

is 26 kcal/mol more stable than **10**. The reason for this is simply that the substitution of boron atoms for carbons in the polyene causes the energy of the b_1 orbital (in Figure 2) to rise.^{1,3c,9} Therefore, the interaction between it and b_2 of the ML_2 unit in **9** is much greater than that between b_2 and the unperturbed b_2 π orbitals in **10**.

From the topology of **3** it may be inferred that one will achieve the largest barrier in benzene- $\text{Fe}(\text{CO})_2$ complexes or isoelectronic analogues with the substitution pattern in **11**. The

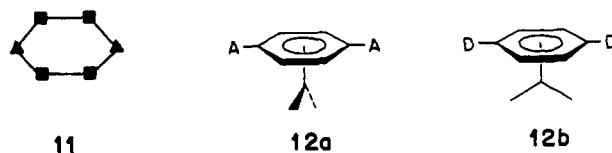

electronegativity of the two para carbons must be perturbed relative to the others. This analysis can be carried one step further by predicting that, with two para acceptor substituents on the benzene ring, the energy of the b_1 π orbital will be lowered; consequently ML_2 b_2 will interact preferentially with the b_2 π orbital giving conformation **12a** as the most stable one. Putting two para donor functions on benzene raises the energy

of the b_1 π orbital so that **12b** should be the most stable orientation. Likewise, the substitution of electronegative nitrogen atoms for C-H groups in the sites marked by triangles in **11** will lead to the most stable conformation of 1,4-diazine-Fe(CO)₂, which should be similar to structure **10**.

The rotational barrier in cyclopentadienyl-Co(CO)₂ is calculated to be very small—0.001 kcal/mol. This is consistent with the variety of conformations found in analogues and derivatives of this complex.¹⁰ We have discussed elsewhere the strategy for creating by substitution a large barrier in these and the related ML₃ compounds.^{1c}

The 18-electron cyclobutadiene-ML₂ complex is predicted to be a rather unstable molecule, with an extremely small barrier to internal rotation when all carbon-carbon bond lengths are kept equal. An interaction diagram is shown in Figure 3 for geometry **13**. Ni(CO)₂ $1b_1$ and b_2 interact in a

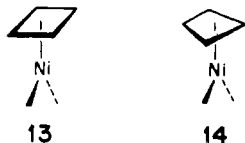

bonding way with the cyclobutadiene nonbonding π level. However, there are still two electrons to be placed, and these enter the antibonding combination of ML₂ $1b_1$ and one component of the e set. This level is at high energy and is responsible for the relative instability of the complex. Upon rotation to the alternative conformation **14**, the $1b_1$ and b_2 orbitals still find a linear combination of the e set to interact with. The rotational barrier should be small.

In a complex of cyclobutadiene with Ni(CO)₂ or some isoelectronic or isolobal analogue (and the first such has just been synthesized¹¹) we think that one of two things will happen. The ML₂ fragment may slip, so that it is complexed in η^2 fashion, leaving a π bond uncomplexed, **15**. Alternatively, if the Ni(CO)₂ remains η^4 , the cyclobutadiene ring will elongate in the manner shown in **16**.

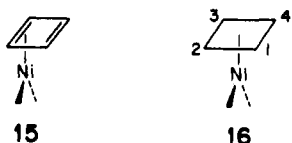

The rationale behind this second deformation is analogous to that found for cyclobutadiene itself.¹² Starting from **13** the two b_1 orbitals will be stabilized upon distortion of cyclobutadiene from a square to a rectangle in the sense defined by **16**. The b_2 orbital, however, will go up in energy. The two b_1 orbitals are each stabilized by approximately the same amount of energy that the b_2 rises, so that the net effect is a rectangular distortion. Although extended Hückel calculations are not expected to be reliable for the calculation of bond lengths, we find that in **16** C₁-C₂ = 1.49 Å and C₂-C₃ = 1.34 Å. Upon rotation to **14** we do not find that distortion to a diamond-shaped structure results in any stabilization. This molecular-cam effect¹³ sets up a barrier in cyclobutadiene-Ni(CO)₂. We calculate **16** to be more stable than **15** (CC optimized at 1.41 Å, the ring a perfect square) by 3.5 kcal/mol. There is one piece of indirect evidence that supports our line of argument. If two electrons are removed from the HOMO in **13**, then the driving force for the rectangular distortion is lost and there will be no barrier of rotation. A structure¹⁴ of a derivative of cyclobutadiene-Ni(Br)₂, which has two less valence electrons, shows that all carbon-carbon bond lengths are approximately equal. Furthermore, the conformation observed for this compound is intermediate between those shown in **13** and **14**.

A moderately large barrier of rotation in cyclobutadienyl-Ni(Br)₂ complexes is expected when the cyclobutadienyl carbons are perturbed in the sense of **17**. Here the electro-

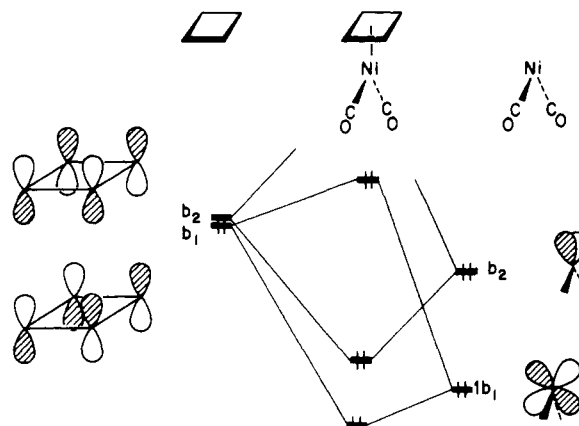
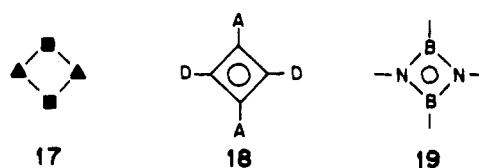
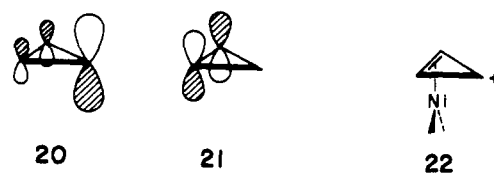

Figure 3. Partial interaction diagram for cyclobutadiene-Ni(CO)₂. Only the ML₂ b_1 and b_2 orbitals and the nonbonding e orbital of cyclobutadiene are shown.



negativity of the carbon atoms given by the triangles is opposite to that of the squares. The perturbation in **17** will split the energy of the formerly degenerate e set¹⁵ so that the interaction of b_2 will be more favorable for one member than the other. Some examples of this would be complexes of push-pull cyclobutadienes, **18**,¹⁶ or the borazetidine, **19**.¹⁷ Determining the most stable conformation of these molecules is identical with the procedure outlined previously for substituted benzene-Fe(CO)₂ complexes, and will not be repeated here. Notice also that the charge distribution set by the perturbation in **17** conforms to the topological requirements for a large barrier as given in the introduction by **3**.

η^3 -Cyclopropenyl-Ni(CO)₂⁺ has a tiny barrier to internal rotation, 0.03 kcal/mol. The ML₂ b_2 orbital can interact with either one of the degenerate π set of cyclopropenium, **20** and **21**, or a combination of these in any conformation. Our cal-



culations, however, show that the Ni(CO)₂ unit prefers to slip off the ring to a dihapto (η^2) position, **22**, by 9 kcal/mol.¹⁸ This distortion has also been noted by Dobosh and Lillya.¹⁹ An X-ray structure²⁰ on the related triphenylcyclopropenyl-Pt(PPh₃)₂ cation shows that the slipping to η^2 does indeed occur. This is due principally to two reasons. Firstly, the overlap of b_2 with **21** increases drastically with the distortion. The overlap of $1b_1$ with **20**, however, drops to zero. Counterbalancing this latter loss is that distortion to η^2 decreases repulsions of a_2 and $2a_1$ with the high-lying set of Walsh orbitals²¹ of cyclopropenium cation and increases overlap of $3a_1$ with the symmetric member of this set.

The ¹H NMR of tris(*tert*-butyl)cyclopropenyl-Ni(CO)Br, which is isoelectronic to **22**, shows all methyl protons to be equivalent at room temperature.²² This implies that either this compound has an η^3 geometry with easy rotation around the cyclopropenium-nickel bond or that there is a facile fluxional motion of the Ni(CO)Br unit around the periphery of the ring. We think that the latter possibility is more likely based on EHT

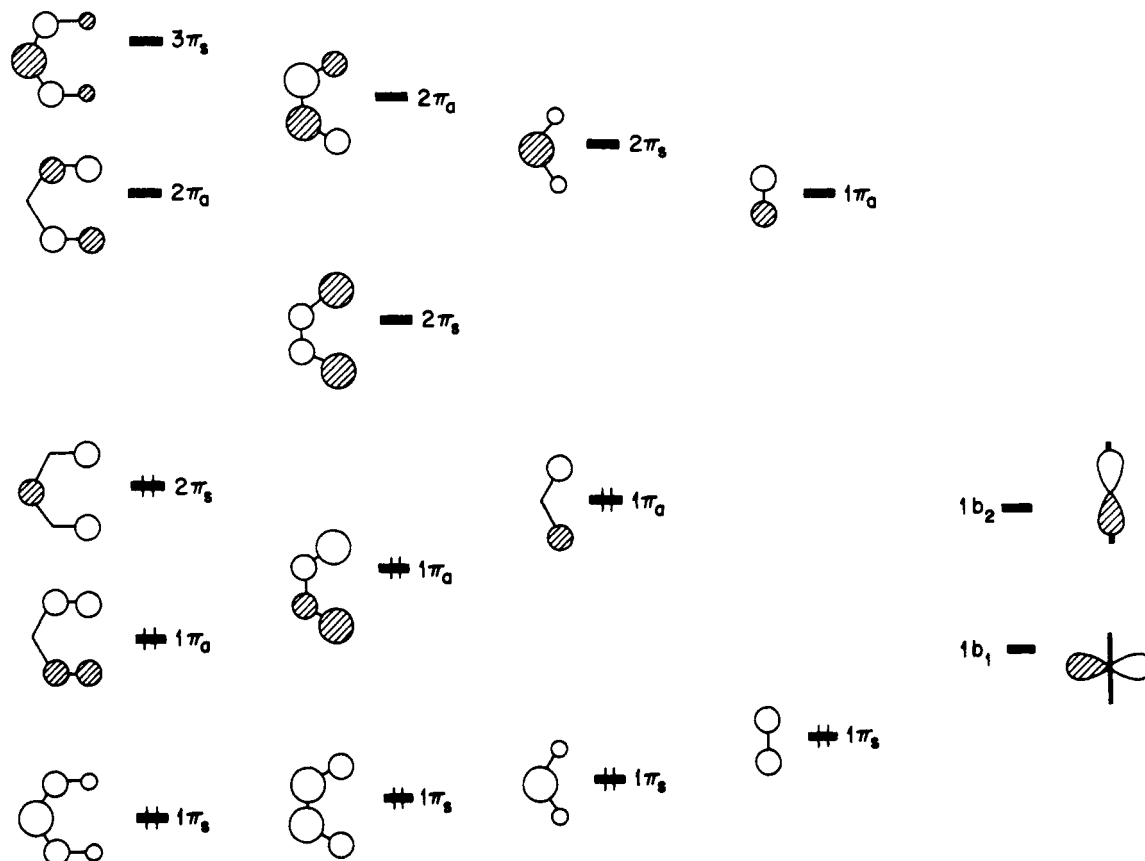
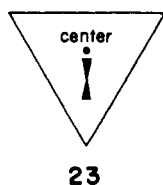

Figure 4. The valence orbitals and approximate energies of acyclic polyenes are presented on the left side of this diagram. The two important orbitals (top view) of the ML_2 unit are shown on the right side.

calculations of this compound.^{19,23} Although a complete theoretical discussion of the fluxionality will be reported elsewhere,²³ a few salient features are worth noting. The transition state for the interchange of η^2 structures is not found at the η^3 geometry. Since there is essentially free rotation at the η^3 geometry this is tantamount to having a transition state with three equivalent exit valleys. Such surfaces have been analyzed in some detail by McIver and Stanton.²⁴ This type of transition state is disallowed on symmetry grounds and the real one corresponds to a less symmetrical portion of the potential surface. This is found to be the case for the cyclopropenyl- $Ni(CO)_2$ cation. The interconversion of η^2 structures involves a transition state, **23**, which is 0.8 kcal/mol more stable than



the η^3 geometry (7.9 kcal/mol less stable than **22**). The molecule in the transition state has C_s symmetry, with one cyclopropenyl carbon atom in the mirror plane which also contains the $Ni(CO)_2$ unit. The projection of the nickel atom onto the plane of the polyene lies 0.13 Å from the center of the cyclopropenyl ring.

Acyclic Polyene- ML_2 Complexes

In the case of ethylene- ML_2 a clear choice was made between conformations **24a** and **24b** on the basis of the relative donor ability of the ML_2 fragment b_2 and $1b_1$ orbitals.² b_2 was at higher energy and better prepared to overlap with ethylene π^* . Accordingly conformation **24a** was much preferred. The

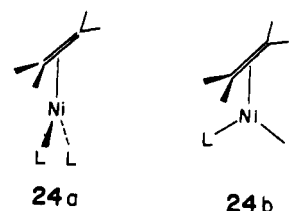

analysis of the conformations of acyclic polyene- ML_2 complexes follows similar lines.

Two extreme conformations are defined, one with the ML_2 group perpendicular to the vertical mirror plane of the polyene, to be called "perpendicular", **25a**, the other "in-plane", with ML_2 in that mirror plane, **25b**. The observed structures show

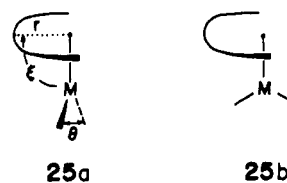

some tilt of the ligand relative to the ML_2 plane, as well as some slipping of the two parts of the molecule. Accordingly it is important to optimize these geometrical parameters— r , the distance from the projection of the metal atom onto the plane of the polyene to the back carbon or CC bond center, ξ , the dihedral angle between the planes of the polyene and the ML_2 unit—as well as θ , the angle between the two ligands. This was done, with results described in the Appendix. The nodal properties and relative energies of the acyclic polyene π levels are crucial to the analysis. These are shown in Figure 4, labeled as symmetric or antisymmetric with respect to the vertical mirror plane, and within each symmetry type labeled serially

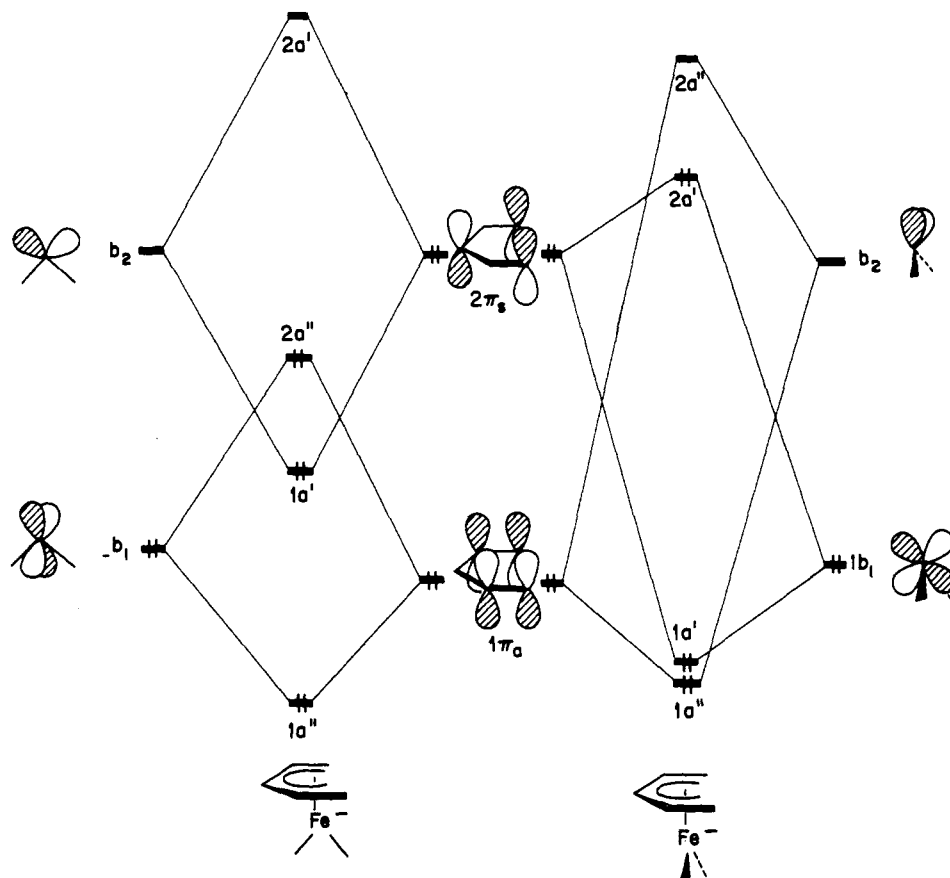

Figure 5. Interaction diagram for pentadienyl-Fe(CO)₂ anion in two possible conformations. Only the orbitals which determine the conformation are shown in this figure.

in order of ascending energy. This numbering scheme will be used in the subsequent discussion.

For a 16-electron π -allyl-ML₂ complex $1\pi_a$ is the HOMO for the allyl fragment and b_2 is formally empty in the ML₂ unit. There is a very strong bonding interaction between b_2 and $1\pi_a$ in the perpendicular, **26**, conformation. This interaction is totally destroyed upon rotation to the in-plane structure, **27**.



Therefore, we predict that the most stable conformation should be the perpendicular one, which is in accord with the available structural evidence.²⁵ Furthermore, there should be a very high barrier of rotation in these complexes. For π -allyl-Ni(PH₃)₂⁺ it is calculated to be 38 kcal/mol. Experimentally, estimation of this barrier is complicated by intermolecular association and collapse to a η^1 -allyl complex.²⁶ Putting two more electrons into the system will reverse the conformation since now both b_2 and $1\pi_a$ are filled. Therefore, b_2 must interact with $2\pi_s$, which is possible only for the in-plane geometry.

For the 16-electron butadiene-Fe(CO)₂ compound b_2 is formally empty and has the correct symmetry to interact with the highest filled π level, $1\pi_a$ (see Figure 4), in the perpendicular geometry, **28**. Upon rotation to the in-plane orientation, **29**, the stabilization of $1\pi_a$ by b_2 is lost and replaced with a



repulsion from the filled $1b_1$ orbital. Again a large barrier (29 kcal/mol) is associated with rotation. Although butadiene-Fe(CO)₂ has been observed in matrix isolation studies,²⁷ there are no details yet on its structure. In the 18-electron butadiene-Ni(CO)₂ complex b_2 is now filled and consequently can be stabilized by the lowest unoccupied level, $2\pi_s$, in the in-plane geometry. There is still repulsion between $1b_1$ and $1\pi_a$. However, if the complex assumes the perpendicular conformation, then the repulsion between $1\pi_a$ and b_2 is much greater (the overlap of $1\pi_a$ is much larger with b_2 than it is with $1b_1$). It is calculated that the in-plane conformer is 69 kcal/mol more stable than the perpendicular one for butadiene-Fe(CO)₂²⁻. Eighteen-electron butadiene complexes are well-known^{28a} and one Ni(R₂PCH₂CH₂PR₂) derivative indeed has structure **29**.^{28b} There does exist one example of a 17-electron system, **30**. It is a bis(trimethyl phosphite)cobalt- η^4 complex of hex-

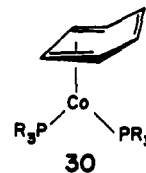

akis(trifluoromethyl)benzene. Its structure shows the CoL₂ group bonded to a butadiene portion of the benzene in the in-plane conformation, as shown in **30**.²⁹ This conformation is calculated to be 15 kcal/mol more stable than the perpendicular one for the isoelectronic butadiene-Fe(CO)₂ anion.

The situation for 16- and 18-electron pentadienyl-ML₂ complexes is somewhat complicated, so the orbital interaction diagram for both conformations is presented in Figure 5. This diagram has been simplified considerably and only includes those orbitals from both fragments that set a conformational preference. The occupancy of the orbitals in Figure 5 corre-

sponds to that in an 18-electron complex. For the in-plane conformation b_2 interacts strongly with $2\pi_s$ and $1b_1$ with $1\pi_a$. The interactions between the alternative combinations for the perpendicular geometry are not as strong, since the interacting orbitals are not in resonance. One interaction with b_2 is a two electron-two orbital, stabilizing one in both conformations. However, there is a four electron-two orbital repulsive interaction with $1b_1$ which also must be considered. This is again much stronger for the in-plane orientation. Our calculations show that the dominant effect for the 18-electron pentadienyl-Fe(CO)₂ anion is the difference between stabilizing interactions. The in-plane geometry was calculated to be 6 kcal/mol more stable than the perpendicular one. There exists a series of palladium(II)-ML₂ complexes isoelectronic to this compound.³⁰ These have a ground-state η^3 geometry, **31**, and undergo a 1,3 shift to **31'** via an η^5 transition state which must have the in-plane orientation, **32**.^{30,31} If two electrons are re-

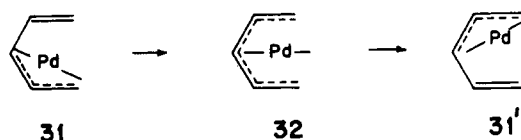

moved from pentadienyl-Fe(CO)₂ anion ($2a''$ for the in-plane and $2a'$ for the perpendicular geometry) then one can see from Figure 5 that the perpendicular conformation should now be the most stable one. The rotational barrier was calculated to be 23 kcal/mol.

The reader will notice that for the 16-electron acyclic polyene-ML₂ complexes it is the interaction of b_2 with $1\pi_a$ (see Figure 4) which can be held responsible for making the perpendicular conformation more stable. On the other hand, it is the interaction of b_2 with $2\pi_s$ for the 18-electron ML₂ complexes which makes the in-plane geometry more favorable.

Polyene-ML₄ Complexes

The two C_{2v} fragments Ni(CO)₂ and Fe(CO)₄ carry very similar orbitals. From Figure 1 one may see that each has a high-lying a_1 and below it a b_2 orbital which is considerably split in energy from its π -bonding partner, b_1 . The resemblance of the two fragments has been discussed in detail in our work on olefin rotational barriers.² In the present context it means that by applying a line of reasoning similar to that in the previous sections we conclude that the rotational barriers in the cyclic C_nH_n -ML₄ **33** should be very small. Those in acyclic polyene-ML₄ should be large, with **34** preferred to **35**. The

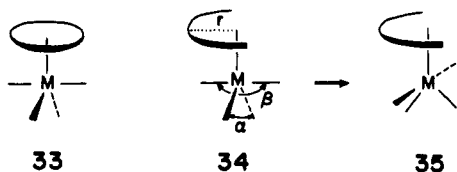

calculations confirm this; the computed barriers in allyl-Mn(CO)₄, butadiene-Cr(CO)₄, and pentadienyl-Cr(CO)₄⁺ were 51, 59, and 11.5 kcal/mol, respectively. These barriers take into account independent optimization of the angle between equatorial carbonyls, α , and slippage of the ML₄ unit with respect to the polyene, r —see **34**. The origin of the barriers again is to be found in the overlap of b_2 from the M(CO)₄ fragment with $2\pi_a$, the polyene orbital nearest to it in energy.

The discussion up to this point has been overly restrictive as far as the local geometry of the ML₄ fragment is concerned. We must worry about the square pyramidal structures **36**–**38** as well. This we proceed to do.

Let us consider the allyl- and cyclopropenyl-ML₄ complexes first, with the aid of the partial interaction diagram **39**. This shows how the degeneracy of the C_{4v} Mn(CO)₄ and the

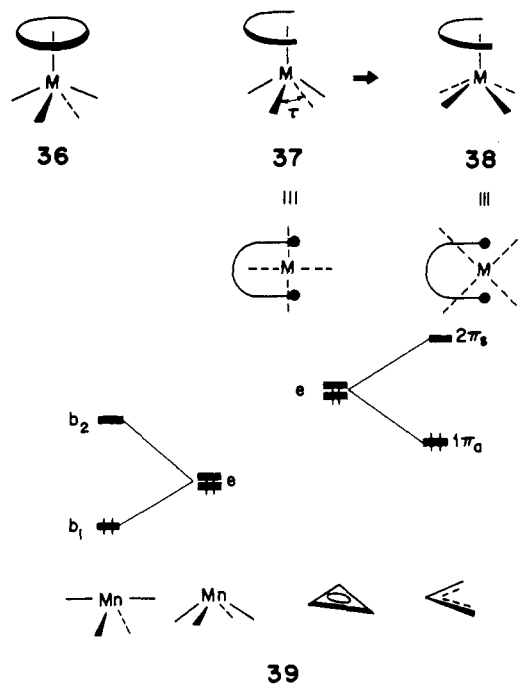

cyclopropenyl orbitals is lifted as the first fragment changes to C_{2v} and the second is (formally) opened to allyl. For cyclopropenyl it appears that interaction with the e set in C_{4v} ML₄ is slightly larger than with $b_1 + b_2$ in C_{2v} . We get the square pyramidal geometry approximately 4 kcal/mol more stable than the trigonal-bipyramidal one. In the allyl system the degeneracy of the e set is lifted and the tremendously strong interaction between $1\pi_a$ and b_2 dominates.

The situation in the allyl system then is very much like that for ethylene. The preferred geometry is **40**, whose resemblance

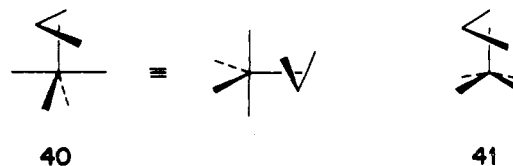

to Fe(CO)₄(ethylene) is best perceived by turning the molecule on its side. Just as in the case of ethylene, the rigid rotation of the allyl group is *not* the most likely process. Instead there takes place a coupled rotation-pseudorotation, with **41** as the transition state. The calculated activation energy is 6 kcal/mol.

The available structural analogues of this compound show the predicted features,³³ namely, the most stable geometry being a trigonal bipyramid with the conformation indicated in **40**. Although several NMR studies have examined the equilibrium between **42** and **43**,³⁴ the mechanism of this in-

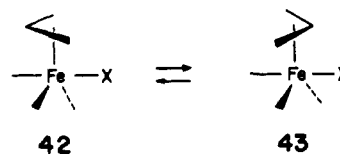

terconversion is not established. We predict that it will not occur by simple rotation of the allyl group.

Within the square pyramidal geometry we found that rotation from conformation **37** to **38** required 2 kcal/mol for Mn(CO)₄-allyl. The source of the barrier is to be found primarily in the repulsion of $1\pi_s$ with a_2 in **38**. There is some support for the notion that **37** is at lower energy than **38** for this system. There exist two structures of π -allyl-ML₅ complexes³⁵ which both have the π -allyl group in the orientation analogous to **37**.

As the polyene becomes larger, steric interactions between the carbonyls and the polyene atoms come into play. A square pyramidal geometry is favored. From our calculations this appears to happen for a butadiene or a larger polyene ligand.

Turning to the other polyene-ML₄ systems, we predict that these will have square-pyramidal ground-state geometries. The barriers to internal rotation for cyclopropenyl-Mn(CO)₄ and cyclopentadienyl-Cr(CO)₄ are miniscule, which would have been expected anyway for a 12- or 20-fold barrier. Although there do not seem to be any trihapto C₃H₃-ML₄ compounds to check our idea, there exist a large number³⁶ of structures containing the Cp ML₄ framework. The orientation of the Cp ring with respect to the ML₄ unit is variable, which indicates a small barrier. The angles between the trans ligands fall generally into two groups. One set has both trans angles equal to ca. 120°, while the others have one set equal to ca. 135° and the other ca. 110°. We calculate τ (defined in 37) to be 123° for CpCr(CO)₄⁺. Although we have not optimized both of the trans angles independently, we expect that there will be only a small energy difference between this geometry and one with $\alpha \approx 110^\circ$, $\beta \approx 135^\circ$, since this is a rather small distortion along the pseudorotation pathway.

Because of the fourfold symmetry in cyclobutadiene, there is expected a rotational barrier for the square-pyramidal cyclobutadiene-Cr(CO)₄ molecule, albeit a rather small one. This is a result of the fact that a₂ can bond, weakly, with the highest unoccupied orbital of the cyclobutadiene ring in the "staggered" conformation. A top view of this is shown in 44.

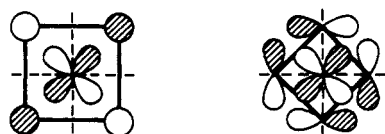

44

45

However, upon rotation to the "eclipsed" geometry, there is a four electron-two orbital repulsion between a₂ and a high-lying σ orbital, illustrated in 45. The secondary interactions between the cyclobutadiene and the carbonyl π^* contributions (which are not shown in 44 and 45) to a₂ accentuate this interaction at large values of τ . The rotational barrier can be sizable at large τ , although a portion of it is of steric origin.

A plot of the computed barrier vs. τ is given in Figure 6. At smaller values of τ the eclipsed geometry becomes more stable. This is a result of the fact that the overlap of the e set in ML₄ with the cyclobutadiene e set of π orbitals is not the same in the two conformations. This is illustrated for one member of the bonding combination in 46 and 47. The overlap in 47 is

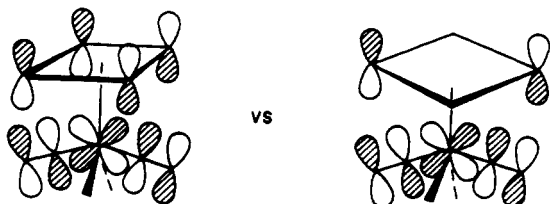

46

47

slightly larger between the ML₄ and cyclobutadiene fragments than it is in 46—0.368 vs. 0.353 for $\tau = 150^\circ$. At this geometry the eclipsed conformation is 1.5 kcal/mol more stable than the staggered. The difference in overlap comes from the differential carbonyl overlap with the cyclobutadiene orbitals. If all overlap between the carbonyls and cyclobutadiene is set to zero, then the staggered orientation becomes 2 kcal/mol more stable than the eclipsed, as it should be if the ideas in 44 and 45 are correct. These two effects compete with each other so that for

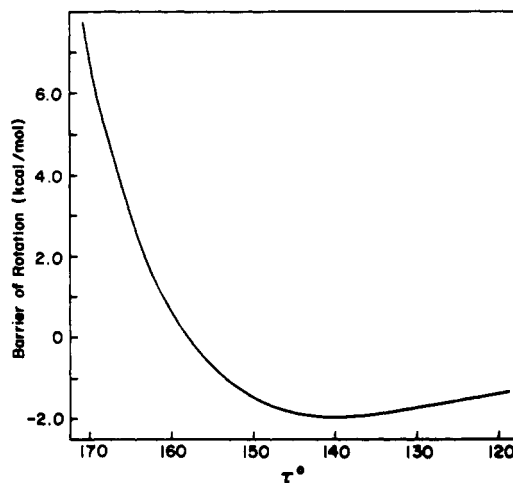

Figure 6. A plot of the rotational barrier in square-pyramidal cyclobutadiene-Cr(CO)₄ as a function of the trans carbonyl angles, τ . A positive value of the barrier corresponds to the staggered geometry being more stable than the eclipsed.

Table I. Parameters Used in Extended Hückel Calculations

orbital	H_{ii} , eV	ζ_1	ζ_2	C_1^a	C_2^a	
Cr	3d	-11.22	4.95	1.60	0.4876	0.7205
	4s	-8.66	1.70			
	4p	-5.24	1.70			
Mn	3d	-11.59	5.15	1.90	0.5320	0.6490
	4s	-8.63	1.80			
	4p	-5.06	1.80			
Fe	3d	-12.70	5.35	1.80	0.5366	0.6678
	4s	-9.17	1.90			
	4p	-5.37	1.90			
Ni	3d	-12.99	5.75	2.00	0.5682	0.6292
	4s	-8.86	2.10			
	4p	-4.90	2.10			
B	2s	-15.20	1.30			
	2p	-8.20	1.30			
C	2s	-21.40	1.625			
	2p	-11.40	1.625			
N	2s	-26.00	1.95			
	2p	-13.40	1.95			
O	2s	-32.30	2.275			
	2p	-14.80	2.275			
F	2s	-40.00	2.425			
	2p	-18.10	2.425			
H	1s	-13.60	1.30			

^a Coefficients in double ζ expansion.

reasonable τ values in cyclobutadiene-Cr(CO)₄ there is only a small barrier. At very large and small values of τ the overlap differential in the e sets diminishes, which gives rise, along with steric effects, to the peculiar dependence of the rotational barrier on τ seen in Figure 6.

Optimization of the two trans carbonyl angles independently for both conformations leads to the eclipsed orientation being 2 kcal/mol more stable than the staggered. The two trans angles in the eclipsed geometry were 134° while in the staggered one was 142° and the other 126°. X-ray structures of cyclobutadiene-Mo(CO)₃(PPh₃) and benzocyclobutadiene-Cr(CO)₃(PPh₃)³⁷ show a variable conformation with one trans carbonyl angle 141–150° and the other trans angle 111–112°. It is likely that the steric bulk of the triphenylphosphine ligand complicates the issue, since our calculations give cyclobutadiene-Cr(CO)₄ at this experimental geometry ($\tau = 145, 110^\circ$) only 4 kcal/mol higher in energy than the optimized geometry given above. The rotational barrier for rigid rotation is minute at this portion of the potential sur-

face—0.1 kcal/mol, which is consistent with variable conformations reported by Davis and Oliver.³⁷

It should be noted that there exists a structure for an interesting η^4 -naphthalene-TaL₅ complex which has the geometry given in 48.³⁸ The overlap of $2\pi_a$ (see Figure 4) for the buta-

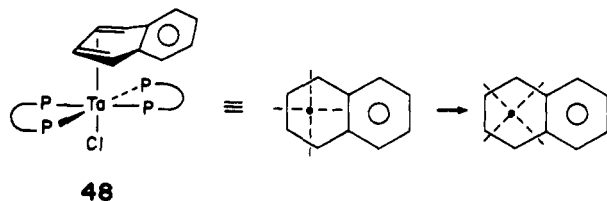

diene portion in 48 with a_2 of the ML₅ unit is maximized. Upon rotation this interaction is lost. Therefore, the source of this barrier, which has been experimentally set at approximately 15 kcal/mol,³⁸ is identical with that presented for cyclobutadiene-Cr(CO)₄ at large values of τ .

Acknowledgment. We are grateful to the members of our research group for valuable discussions and to R. E. Davis, I. Bernal, and P. Bird for the communication of results prior to publication. The drawings were contributed by J. Jorgensen and the typing by R. Ludgate. Our research was supported by the National Science Foundation through Research Grant CHE 7606099. R.H. gratefully acknowledges the hospitality of the Department of Organic, Inorganic, and Theoretical Chemistry at Cambridge University, where this work was completed.

Appendix

The calculations were carried out with the extended Hückel method.³⁹ The H_{ii} 's for Cr, Fe, and Mn were taken from previous work,¹ while those for Ni were obtained from a charge iterative calculation on ethylene-Ni(CO)₂.² The metal orbital exponents for the 3d functions are those given by Richardson, Basch et al.⁴⁰ Those for the 4s and 4p functions were taken from previous work.⁴¹ The parameters are listed in Table I. A modified Wolfsberg-Helmholz formula was used.⁴² The following idealized bond distances were employed: C-H, 1.09; C-O, 1.14; C-C, 1.41 Å. All C-C-C, C-C-H (for the acyclic polyenes), and M-C-O angles were set at 120, 120, and 180°, respectively. The M-C(O) distances were set at Cr, 1.84; Fe, 1.78; Mn, 1.80; Ni, 1.82 Å. The metal to polyene ring distances were fixed at allyl, 1.72; butadiene, 1.64; pentadienyl, 1.69; cyclopropenyl, 2.04; cyclobutadiene, 1.78; cyclopentadienyl, 1.69; benzene, 1.73 Å. The values for r and ξ in 24 were optimized to be for allyl, 0.65 Å, 93°; butadiene, 0.74 Å, 100°; pentadienyl, 1.18 Å, 90° (assumed).

References and Notes

- (1) T. A. Albright, P. Hofmann, and R. Hoffmann, *J. Am. Chem. Soc.*, **99**, 7546 (1977); (b) *Chem. Ber.*, **111**, 1591 (1978); (c) T. A. Albright and R. Hoffmann, *ibid.*, **111**, 1578 (1978).
- (2) T. A. Albright, R. Hoffmann, J. C. Thibeault, and D. L. Thorn, *J. Am. Chem. Soc.*, preceding paper in this issue.
- (3) (a) M. Elian and R. Hoffmann, *Inorg. Chem.*, **14**, 1058 (1975); (b) J. K. Burdett, *Inorg. Chem.*, **14**, 375 (1975); *J. Chem. Soc., Faraday Trans. 2*, **70**, 1599 (1974); (c) D. M. P. Mingos, *J. Chem. Soc., Dalton Trans.*, 602 (1977); *Adv. Organomet. Chem.*, **15**, 1 (1977); (d) P. Hofmann, *Angew. Chem.*, **89**, 551 (1977); Habilitation, Erlangen, 1978.
- (4) M. J. Nolte and G. Gafner, *Acta Crystallogr., Sect. B*, **30**, 738 (1974); M. J. Nolte, G. Gafner, and L. M. Haines, *Chem. Commun.*, 1406 (1969). See also R. R. Schrock and J. A. Osborn, *Inorg. Chem.*, **9**, 2339 (1970).
- (5) H. Schmidt and M. L. Ziegler, *Chem. Ber.*, **109**, 132 (1976).
- (6) G. J. Kruger, A. L. du Preez, and R. J. Haines, *J. Chem. Soc., Dalton Trans.*, 1302 (1974).
- (7) B. B. Anderson, C. L. Behrens, L. J. Radonovich, and K. J. Klabunde, *J. Am. Chem. Soc.*, **98**, 5390 (1976).
- (8) J. A. K. Howard, I. W. Kerr, and P. Woodward, *J. Chem. Soc., Dalton Trans.*, 2466 (1975); P. S. Maddern, A. Modinos, P. L. Timms, and P. Woodward, *ibid.*, 1272 (1975).
- (9) E. Heilbronner and H. Bock, "Das HMO Modell und Seine Anwendung", Verlag Chemie, Weinheim/Bergstr., Germany, 1968.
- (10) M. J. Bennett, J. L. Pratt, and R. M. Tuggle, *Inorg. Chem.*, **13**, 2408 (1974); G. Evrard, R. Thomas, B. R. Davis, and I. Bernal, *J. Organomet. Chem.*, **124**, 59 (1977); L. J. Guggenberger and R. Cramer, *J. Am. Chem. Soc.*, **94**, 3779 (1972); V. W. Day, B. R. Stults, and K. J. Reimer, *ibid.*, **96**, 1227 (1974); K. J. Reimer and A. Shaver, *Inorg. Chem.*, **14**, 2707 (1975); J. A. Ibers, *J. Organomet. Chem.*, **73**, 389 (1974); F. Glocking, A. McGregor, M. L. Schneider, and H. M. M. Shearer, *J. Inorg. Nucl. Chem.*, **32**, 3101 (1970); M. Arthurs, S. M. Nelson, and M. G. B. Drew, *J. Chem. Soc., Dalton Trans.*, 779 (1977); M. R. Churchill and T. A. O'Brien, *J. Chem. Soc. A*, 2970 (1968); 266 (1969); C. G. Pierpont, H. H. Downs, K. Itoh, H. Nishiyama, and I. Ishii, *J. Organomet. Chem.*, **124**, 93 (1976); N. L. Holy, N. C. Baenziger and R. M. Flynn, *Angew. Chem., Int. Ed. Engl.*, **17**, 686 (1978).
- (11) U. Griebisch and H. Hoberg, *Angew. Chem.*, **90**, 1014 (1978).
- (12) E. A. Halevi, F. A. Matsen, and T. L. Welsler, *J. Am. Chem. Soc.*, **98**, 7088 (1976), and references cited therein; see also H. Irngartinger and H. Rodewald, *Angew. Chem.*, **86**, 783 (1974), for experimental evidence.
- (13) For discussions of organic molecules that show similar distortions upon rotation, see W. J. Hehre, *Acc. Chem. Res.*, **8**, 369 (1975).
- (14) H.-J. Schmitt, K. Weidenhammer, and M. L. Ziegler, *Chem. Ber.*, **109**, 2558 (1976).
- (15) R. Hoffmann, *Chem. Commun.*, 240 (1969).
- (16) R. Gompfer, J. Kroner, G. Seybold, and H. U. Wagner, *Tetrahedron*, **32**, 629 (1976), and references cited therein.
- (17) For calculations on this molecule see N. C. Baird, *Inorg. Chem.*, **12**, 473 (1973); R. Hoffmann, *J. Chem. Phys.*, **40**, 2474 (1964).
- (18) The carbon-carbon bond lengths were kept fixed at 1.41 Å and the nickel-carbon bond lengths were 2.20 Å in the η^3 geometry and 2.00 Å in the η^2 geometry.
- (19) P. A. Dobosh and C. P. Lillya, private communications.
- (20) M. D. McClure and D. L. Weaver, *J. Organomet. Chem.*, **54**, C59 (1973).
- (21) A description of these σ orbitals can be found in W. L. Jorgensen and L. Salem, "The Organic Chemist's Book of Orbitals", Academic Press, New York, 1973, pp 19-23, 115.
- (22) W. K. Olander and T. L. Brown, *J. Am. Chem. Soc.*, **94**, 2139 (1972).
- (23) T. A. Albright, to be published.
- (24) R. E. Stanton and J. W. McIver, Jr., *J. Am. Chem. Soc.*, **97**, 3632 (1975); J. W. McIver, Jr., *ibid.*, **94**, 2625 (1972); *Acc. Chem. Res.*, **7**, 72 (1974); T. D. Bouman, C. D. Duncan, and C. Trindle, *Int. J. Quantum Chem.*, **11**, 399 (1977).
- (25) (a) T. S. Cameron and C. K. Prout, *Acta Crystallogr., Sect. B*, **28**, 2021 (1972); T. S. Cameron, M. L. H. Green, H. Munakata, C. K. Prout, and M. J. Smith, *J. Coord. Chem.*, **2**, 43 (1972); (b) E. Benedetti, G. Maglio, P. Palumbo, and C. Pedone, *J. Organomet. Chem.*, **60**, 189 (1973); A. Musco, R. Rampone, P. Garis, and C. Pedone, *ibid.*, **50**, 327 (1973); (c) B. L. Barnett and C. Krüger, *ibid.*, **77**, 407 (1974); B. Barnett, B. Büssemeier, P. Heimbach, P. W. Jolly, C. Krüger, I. Tkatchenko, and G. Wilke, *Tetrahedron Lett.*, 1457 (1972); (d) H. Zeiner, R. Ratka, and M. L. Ziegler, *Z. Naturforsch. B*, **32**, 172 (1977); (e) Y. Kitano, T. Kajimoto, M. Kashiwagi, and T. Kinoshita, *J. Organomet. Chem.*, **33**, 123 (1971); (f) G. Perego, G. Del Piero, and M. Cesari, *Cryst. Struct. Commun.*, **3**, 721 (1974); (g) G. D. Andretti, G. Bocelli, and P. Sgarabotto, *ibid.*, **3**, 103 (1974); (h) S. Kota, A. Takenaga, and T. Watanabe, *Bull. Chem. Soc. Jpn.*, **44**, 653 (1971); (i) A. Striga, *Chem. Commun.*, 256 (1969); *Inorg. Chem.*, **9**, 2245 (1970); (j) H. A. Graf, R. Huttel, G. Nagorsen, and B. Rau, *J. Organomet. Chem.*, **136**, 389 (1977); (k) M. Zocchi and A. Albinati, *ibid.*, **77**, C40 (1974); (l) S. Candeloro De Sanctis, N. V. Pavel, and L. Toniolo, *ibid.*, **108**, 409 (1976); (m) A. E. Smith, *Acta Crystallogr.*, **18**, 331 (1965); (n) S. J. Lippard and S. M. Morehouse, *J. Am. Chem. Soc.*, **94**, 6956 (1972); (o) T. A. Broadbent and G. E. Pringle, *J. Inorg. Nucl. Chem.*, **33**, 2009 (1971); (p) P. M. Bailey, B. E. Mann, A. Segnitz, K. L. Kaiser, and P. M. Maitlis, *J. Chem. Soc., Chem. Commun.*, 567 (1974); (q) J. D. Smith and J. D. Oliver, *Inorg. Chem.*, **17**, 2585 (1978). (r) Also see L. J. Guggenberger, A. R. Kane, and E. L. Muetterties, *J. Am. Chem. Soc.*, **94**, 5665 (1974), for a borane analogue.
- (26) (a) For reviews see K. Vrieze and P. W. N. M. vanLeeuwen, *Prog. Inorg. Chem.*, **14**, 1 (1971); K. Vrieze in "Dynamic Nuclear Magnetic Resonance Spectroscopy", L. M. Jackman and F. A. Cotton, Eds., Academic Press, New York, 1975, pp 441-488; H. L. Clarke, *J. Organomet. Chem.*, **80**, 155 (1974). (b) See H. C. Clark and C. R. Jablonski, *Inorg. Chem.*, **14**, 1518 (1975); J. A. Kaduk and J. A. Ibers, *J. Organomet. Chem.*, **139**, 199 (1977); M. Wada and T. Wakabayashi, *ibid.*, **96**, 301 (1975); Z. Kanda, Y. Nakamura, and S. Kawaguchi, *Inorg. Chem.*, **17**, 910 (1978), for some of the more recent work in this area.
- (27) J. K. Burdett, private communication.
- (28) (a) See, for example, P. W. Jolly and G. Wilke, "The Organic Chemistry of Nickel", Vol. 1, Academic Press, New York, 1974, pp 264-266. (b) C. Krüger, private communication.
- (29) P. Bird, private communication.
- (30) B. E. Mann and P. M. Maitlis, *J. Chem. Soc., Chem. Commun.*, 1058 (1976).
- (31) This reaction has been studied in detail by D. M. P. Mingos, to be published.
- (32) Optimized $\alpha = 102^\circ$, $\beta = 180^\circ$ for the structure corresponding to 34, and $\tau = 142^\circ$ for 38.
- (33) (a) J. A. Kaduk, A. T. Poulos, and J. A. Ibers, *J. Organomet. Chem.*, **127**, 245 (1977); T. H. Tulip and J. A. Ibers, *J. Am. Chem. Soc.*, **100**, 3252 (1978); (b) I. W. Bassi and R. Scordamaglia, *J. Organomet. Chem.*, **51**, 273 (1973); (c) M. Kh. Minasyants and Yu. T. Struchkov, *Zh. Strukt. Khim.*, **9**, 577 (1968); M. Kh. Minasyants, Yu. T. Struchkov, I. I. Kritskaya, and R. L. Avogon, *ibid.*, **7**, 840 (1966); A. N. Nesmeyanov, M. I. Rybinskaya, L. V. Rybin, N. T. Gubenko, N. G. Bokii, A. S. Bastsanov, and Yu. T. Struchkov, *J. Organomet. Chem.*, **149**, 177 (1978). (d) For attempts to measure the barriers by NMR, see A. Oudeman and T. S. Sorenson, *ibid.*, **156**, 259 (1978); D. H. Gibson and T.-S. Ong, *ibid.*, **155**, 221 (1978).
- (34) A. N. Nesmeyanov, Yu. A. Ustyuyuk, I. I. Kritskaya, and G. A. Schembelov, *J. Organomet. Chem.*, **14**, 395 (1968); A. N. Nesmeyanov, N. P. Avakyan, and I. I. Kritskaya, *Izv. Akad. Nauk SSSR, Ser. Khim.*, **25**, 1768

- (1976); A. N. Nesmeyanov, L. A. Fedorov, N. P. Avakyan, P. V. Petrovskii, E. I. Fedin, E. V. Arshavskaya, and I. I. Kritskaya, *J. Organomet. Chem.*, **101**, 121 (1975); E. W. Randall, E. Rosenberg, and L. Milone, *J. Chem. Soc., Dalton Trans.*, 1672 (1973); C. S. Eschbach, D. Seyferth, and P. C. Reeves, *J. Organomet. Chem.*, **104**, 363 (1976). (b) Spin saturation transfer techniques have shown that this isomerization cannot occur via $\pi-\sigma-\pi$ rearrangements: J. W. Faller, *Adv. Organomet. Chem.*, **16**, 211 (1977).
- (35) M. Schneider and E. Weiss, *J. Organomet. Chem.*, **121**, 189 (1976); U. Franke and E. Weiss, *ibid.*, **139**, 305 (1977). Recent NMR work on analogues has established rotational barriers of ca. 10 kcal/mol: J. W. Faller and D. A. Haitko, *ibid.*, **149**, C19 (1978); G. Doyle, *ibid.*, **150**, 67 (1978). See, however, J. W. Faller, D. A. Haitko, R. D. Adams, and D. F. Chodosh, *J. Am. Chem. Soc.*, **99**, 1634 (1977), where the opposite conformation (**38**) is found in a structure.
- (36) (a) M. R. Churchill and J. P. Fennessey, *Inorg. Chem.*, **7**, 953 (1968); **6**, 1213 (1967); M. R. Churchill and S. W.-Y. Chang, *ibid.*, **14**, 98 (1975); P. H. Bird and M. R. Churchill, *ibid.*, **7**, 349 (1968); (b) M. G. Reisner, I. Bernal, H. Brunner, and J. Wächter, *J. Organomet. Chem.*, **137**, 329 (1977); M. G. Reisner, I. Bernal, H. Brunner, and M. Muschiol, *Inorg. Chem.*, submitted for publication; S. J. La Placa, I. Bernal, H. Brunner, and W. A. Herrmann, *Angew. Chem.*, **87**, 379 (1975); I. Bernal, S. J. La Placa, J. Krop, H. Brunner, and W. A. Herrmann, *J. Am. Chem. Soc.*, submitted for publication; I. Bernal and M. G. Reisner, private communications; (c) J. B. Wilford and H. M. Powell, *J. Chem. Soc. A*, 8 (1969); J. B. Wilford, A. Whitla and H. M. Powell, *J. Organomet. Chem.*, **8**, 495 (1967); (d) M. A. Bush, A. D. U. Hardy, L. Manojlovic-Muir, and G. A. Sim, *J. Chem. Soc., A*, 1003 (1971); A. T. McPhail, G. R. Knox, C. G. Robertson, and G. A. Sim, *ibid.*, 205 (1971); A. D. U. Hardy and G. A. Sim, *J. Chem. Soc., Dalton Trans.*, 1900 (1972); (e) A. M. Ciplys, R. J. Geue, and M. R. Snow, *ibid.*, 35 (1976); (f) P. D. Brotherton, J. M. Epstein, A. H. White, and S. B. Wild, *Aust. J. Chem.*, **27**, 2667 (1974); M. M. Mickiewicz, C. L. Raston, A. H. White and S. B. Wild, *ibid.*, **30**, 1685 (1977); (g) N. I. Kirillova, A. F. Gusev, A. A. Pasynskii, and Yu. T. Struchkov, *Zh. Strukt. Khim.*, **15**, 288 (1974); V. A. Semion and Yu. T. Struchkov, *ibid.*, **9**, 1046 (1968); V. A. Semion, Yu. A. Chapovskii, Yu. T. Struchkov, and A. N. Nesmeyanov, *Chem. Commun.*, 666 (1968); B. P. Bir'yukov, Yu. T. Struchkov, K. N. Ansimov, N. E. Kolobova, and A. S. Beschastnov, *ibid.*, 667 (1968); A. G. Ginzburg, N. G. Bokyi, A. I. Yanovsky, Yu. T. Struchkov, V. N. Setkina, and D. N. Kursanov, *J. Organomet. Chem.*, **136**, 45 (1977); T. N. Salnikova, V. G. Andrianov, and Yu. T. Struchkov, *Koord. Khim.*, **2**, 707 (1976); (h) R. H. Fenn and J. H. Cross, *J. Chem. Soc. A*, 3312 (1971); S. Chaiwasie and R. H. Fenn, *Acta Crystallogr., Sect. B*, **24**, 525 (1968); (i) J. R. Knox and C. K. Prout, *ibid.*, **25**, 1952 (1969); J. K. P. Ariyaratne, A. M. Bjerrum, M. L. H. Green, M. Ishaq, C. K. Prout, and M. G. Swainick, *J. Chem. Soc. A*, 1309 (1969); M. L. H. Green, J. K. P. Ariyaratne, A. M. Bjerrum, M. Ishaq, and C. K. Prout, *Chem. Commun.*, 430 (1967); (j) M. J. Bennett and R. Mason, *Proc. Chem. Soc., London*, 273 (1963); R. A. Smith and M. J. Bennett, *Acta Crystallogr., Sect. B*, **33**, 1113, 1118 (1977); (k) R. J. Doedens and L. F. Dahl, *J. Am. Chem. Soc.*, **87**, 2576 (1965); H. W. Baird, Ph.D. Thesis, University of Wisconsin, 1963; (l) G. A. Jones and L. J. Guggenberger, *Acta Crystallogr., Sect. B*, **31**, 900 (1975); (m) R. M. Kirchner and J. A. Ibers, *Inorg. Chem.*, **13**, 1667 (1974); R. M. Kirchner, J. A. Ibers, M. S. Saran, and R. B. King, *J. Am. Chem. Soc.*, **95**, 5775 (1973); (n) L. Y. Y. Chan, W. K. Dean, and W. A. G. Graham, *Inorg. Chem.*, **16**, 1067 (1977); (o) A. Mawby and J. E. Pringle, *J. Inorg. Nucl. Chem.*, **34**, 525 (1972); (p) J. N. St. Denis, W. Butler, M. D. Glick, and J. P. Oliver, *J. Organomet. Chem.*, **129**, 1 (1977) (here the trans angles are 101.8 and 123.5°); (q) R. B. King, M. G. Newton, J. Gimeno, and M. Chang, *Inorg. Chim. Acta*, **23**, L35 (1977); (r) J. E. O'Conner and E. R. Corey, *J. Am. Chem. Soc.*, **89**, 3939 (1967); (s) D. Rehder, I. Müller, and J. Kopf, *J. Inorg. Nucl. Chem.*, **40**, 1013 (1978).
- (37) Raymond Davis, private communication; J. D. Oliver, Ph.D. Dissertation, University of Texas at Austin, 1971.
- (38) J. O. Albright, L. D. Brown, S. S. Datla, J. K. Louba, S. S. Wreford, and B. M. Foxman, *J. Am. Chem. Soc.*, **99**, 5518 (1977); S. S. Wreford, private communication.
- (39) R. Hoffmann, *J. Chem. Phys.*, **39**, 1397 (1963); R. Hoffmann and W. N. Lipscomb, *ibid.*, **36**, 3179, 3489 (1962); **37**, 2872 (1962).
- (40) J. W. Richardson, W. C. Nieuwpoort, R. R. Powell, and W. F. Edgell, *J. Chem. Phys.*, **36**, 1057 (1962); H. Basch and H. B. Gray, *Theor. Chim. Acta*, **4**, 367 (1966).
- (41) R. H. Summerville and R. Hoffmann, *J. Am. Chem. Soc.*, **98**, 7240 (1976).
- (42) J. H. Ammeter, H.-B. Bürgi, J. C. Thibeault, and R. Hoffmann, *J. Am. Chem. Soc.*, **100**, 3686 (1978).

M_2L_9 Complexes

Richard H. Summerville and Roald Hoffmann*

Contribution from the Department of Chemistry, Cornell University, Ithaca, New York 14853. Received January 12, 1979

Abstract: The electronic and geometrical structure of confacial bioctahedral complexes of the type $L_3MX_3ML_3$ is studied, for a variety of terminal ligands and hydride, halide, and carbonyl as representative bridging ligands. The factors which determine the dimer geometry in general and the metal-metal separation in particular are the geometrical preference of the L_3MX_3 monomer fragment, the symmetry-conditioned opportunities for interaction offered up by the orbitals of the bridging group (very different for H^- , Cl^- , or CO), and direct metal-metal bonding. There are cases in this class of triply bridged complexes where metal-metal bonding is determinative, but they are a minority. Several cases point up the fact that in bridged complexes neither a short metal-metal distance by itself nor electron counting conventions are a good guide to the presence or absence of substantial direct metal-metal interaction.

A convenient but not unique theoretical approach to bridged metal dimer (and cluster) complexes is to view the following three factors as determining the dimer molecular geometry and electronic structure: (1) the geometrical preference of the monomer fragment; (2) the symmetry-conditioned opportunity for interaction offered up by the orbitals of the bridging groups; (3) direct bonding or antibonding overlap of primarily metal-centered orbitals. The mix of these contributions is variable. In many cases, especially those in which compounds are compared which differ from each other only by one or two electrons, the last effect is important. This is clearly seen in the elegant body of work of Dahl and collaborators.¹ In other cases all three factors may enter, and direct metal-metal bonding may be relatively unimportant. In three previous papers we have implemented the protocol of analysis specified above, in a study of the superexchange problem in weakly coupled d^9 dimers,² in a detailed investigation of alternative geometries of M_2L_6 complexes,³ and in a discussion of triple-decker sandwiches.⁴ This contribution

deals with metal dimers bridged by three ligands, the M_2L_9 class of compounds. A number of these face-shared bioctahedra have been analyzed in terms of structural distortions and the 18-electron rule by Cotton and Ucko.⁵ We will expand on their important study using qualitative molecular orbital (MO) arguments and extended Hückel calculations.

The method of Cotton and Ucko was based on the important insight that in bridged metal dimers a number of structural variables are interdependent. In complex **1** it takes one dis-

